

## Stinger Laser Analyzer installation

These instructions are an addition to the DSI Quick Installation Manual. Installations of the Lasers has to be done accurately to ensure optimal performance.

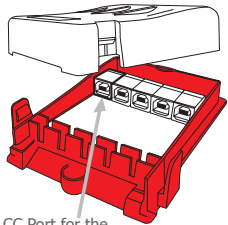

CC Port for the Extension Box

### Laser Analyzer Box

Place the Laser Analyzer Box under the hood.

- Connect the Laser Analyzer Box to the Extension Box with the plug in the left “CC port” and connect the other end in the Extension Box in a random port. Do not yet close the lid.

### Lasers

The Lasers must have an unobstructed ‘view’. Connect the Lasers to port 1, 2, 3, or 4 of the Laser Analyzer Box.

### Determining the location of the Lasers

**Front Lasers:** The recommended height to place the Lasers is between the levels of the licence plate and the headlight units of the car. If only one Laser is used, mount it exactly in the center front of the vehicle. If more than one Laser is placed, divide them evenly around the center of the car. It’s advised to not place Lasers further than 60cm horizontally apart.

Each Laser should point straight forward and be installed parallel to the road.

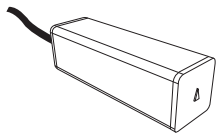
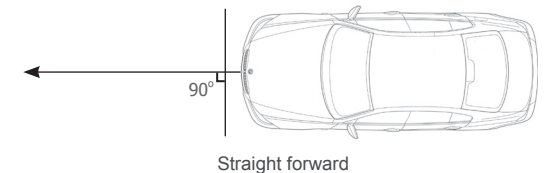
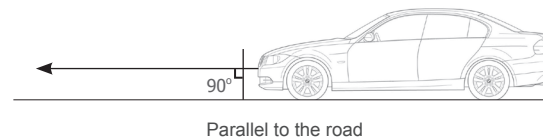
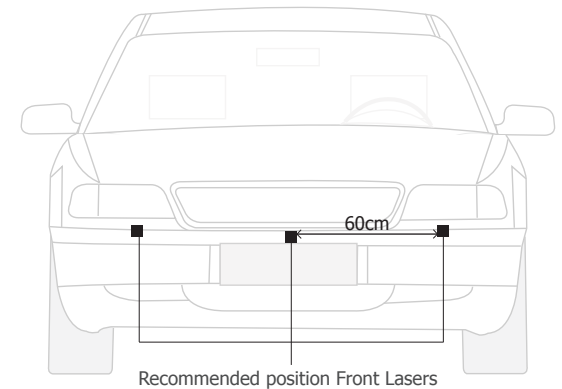

### Front Laser Square

Place the Laser in the grill, making sure the arrow is pointing up. Make sure the Laser faces straight forward and is mounted flush.

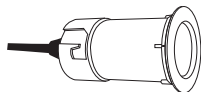

### Front Laser Round

Drill a 21 mm opening in the bumper or spoiler. Using the angled rings, place the Laser facing as straight forward as possible. Fasten the Laser with the provided spring and ring.

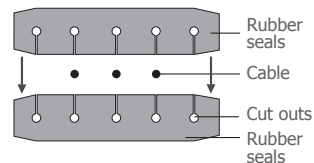

### Closing the Laser Analyzer Box

After all the cables have been connected, it is important to close the boxes (see picture 2 and 5) in a water resistant manner. Place the cables in the cut outs of the included ‘rubber seals’ (see example). This avoids humidity getting into the box via the cables.

Next, place the rubber seals with the now inserted cables into the slot, as depicted in the example on the left. Make sure the rubbers are pushed down all the way using silicone spray to facilitate this. Put the lid on the box in a straight and tight manner.

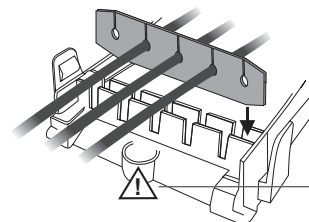

Please be careful not to damage the cable on the installation ring located at the center of the Extension Box (see example).